

# JETE

## USER MANUAL

### PORTABLE FAN TF5

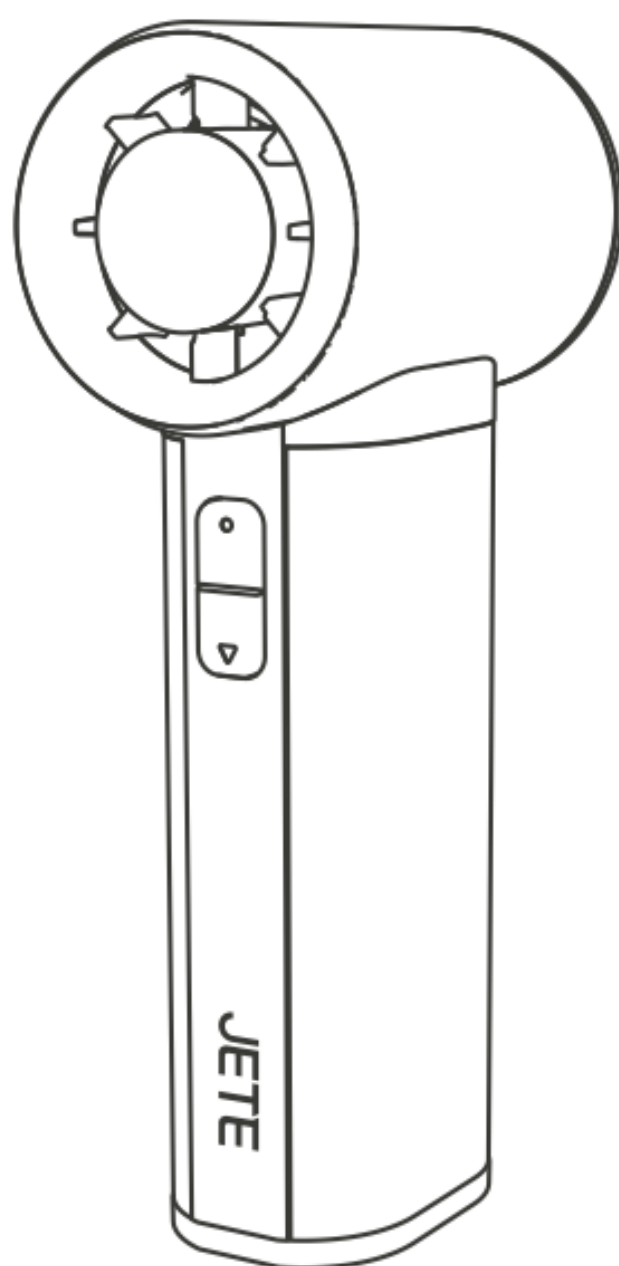

Please read the instructions carefully  
before using the product.

## Product Introduction :

Thank you for purchasing JETE products. For optimal and safe performance, it is expected to read the instructions carefully before using this product.

## Content Package :

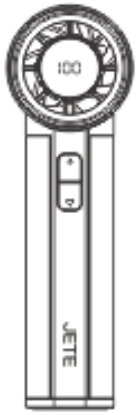

TF5

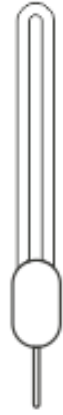

Strap

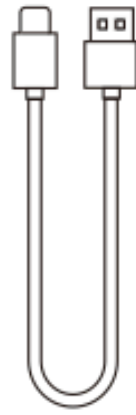

Charging Cable

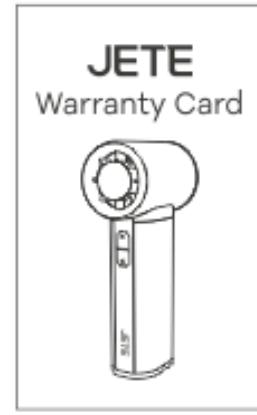

User Manual

## Description Structure Product :

LED Display

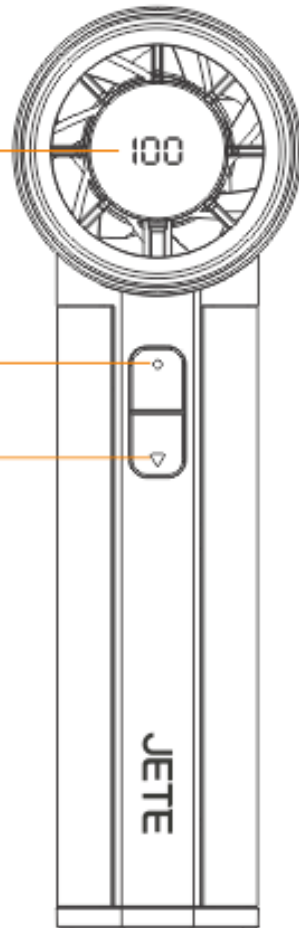

Level + Button

Level - Button

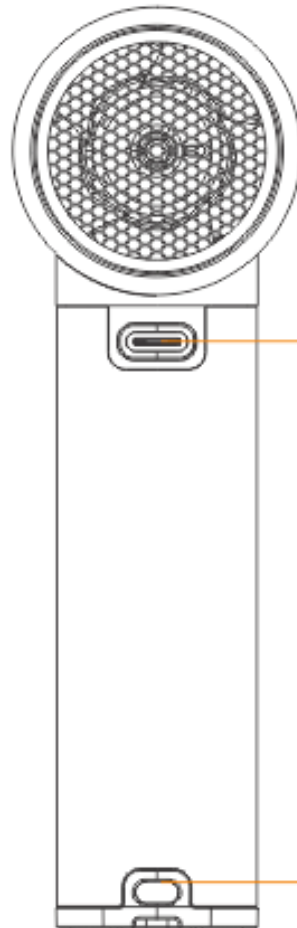

Port USB-C

Strap Hole

## Tips:

- Regular use of the fan is the easiest form of maintenance.
- It is recommended to operate the fan at a medium speed, as this can help extend the fan's lifespan.

## How to Use :

### How to Turn the Fan On and Off

- Press the Level + button once to turn on the fan and switch to a speed level.
- Press the Level + button twice quickly to turn off the fan.

### Cara Mengatur Kecepatan Kipas :

#### 1. "+" Button

- a. Press once to switch to Speed Level 25.
- b. Press again to switch to Speed Level 50.
- c. Press again to switch to Speed Level 75.
- d. Press again to switch to Speed Level 100.
- e. Press and hold to freely select the desired speed level.

#### 2. "-" Button

- a. Press once to decrease the speed level step by step.
- b. Press and hold to continuously reduce the speed to the desired level.

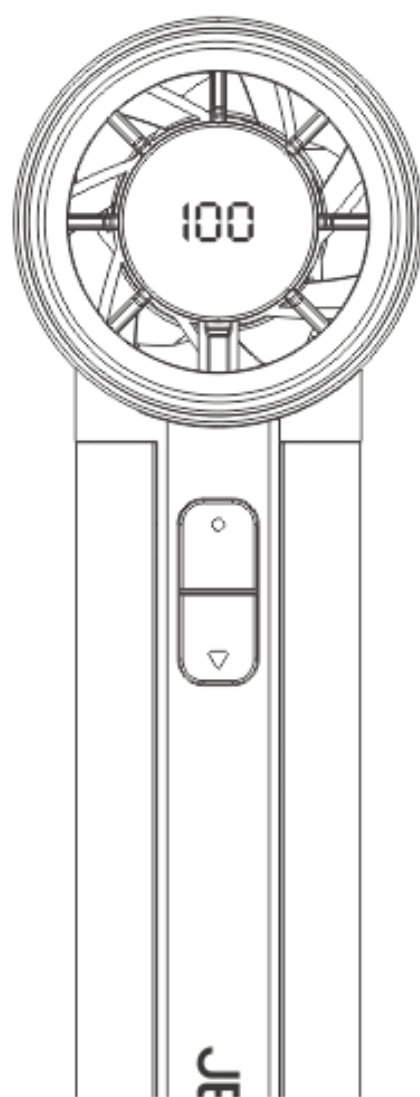

## Notes

After selecting the speed, the LED Display will automatically switch to the battery percentage (%) indicator.

## Operating Time After Fully Charged

Operating Mode	Usage Time
Speed Level 1	±12 hours
Speed Level 25	±10 hours
Speed Level 50	±6 hours
Speed Level 75	±4 hours
Speed Level 100	±2.5 hours

## Charging Instructions

- Use a USB-C charging cable (DC 5V/2A) for charging.
- For first-time use, charge the fan for 2 hours.
- During charging, the LED Display will light up and show the battery percentage.

## Product Specification :

Power Input	: DC 5V / 2A
Maximum Output Power	: 5W
Battery Capacity	: 4500 mAh
Maximum Wind Speed	: 12 m/s
Motor Speed	: 20,000 RPM (MAX)
Number of Blades	: 5
Operating Time	: 2.5–12 hours
Charging Time	: 4 hours
Product Dimensions	: 40 × 61 × 128.5 mm
Product Weight	: 176 g
Material	: Aluminum Alloy + ABS

# JETE

**WARRANTY CARD and  
USER MANUAL**

**PORTABLE FAN TF5**

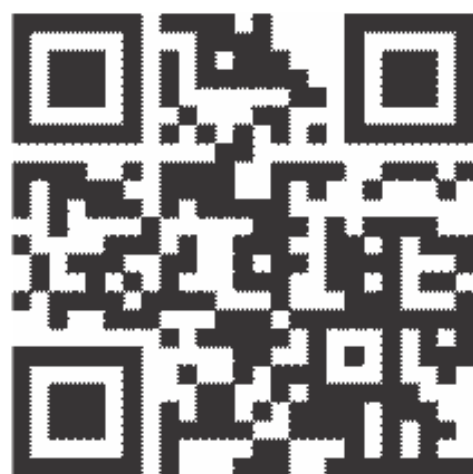

e-Usermanual

IMPORTIR

**PT. DORAN SUKSES INDONESIA**

Jl. Lebak Jaya 2 Tengah No. 2, Surabaya

CUSTOMER SERVICE

 081217393609

 jete.id  jeteindonesia

 jeteindonesia  jeteindonesia

## Maintenance :

Please read the following recommendations before using JETE

- Avoid exposing the device to water vapor or humid places. This can affect the internal circuit.
- Do not use cleaning solutions to clean the device.
- Do not expose the device to extreme heat or cold, as this can damage the device or change certain plastic parts.
- Avoid exposing the device to sharp objects, as this can cause scratches and damage.
- Do not disassemble or modify the device.
- Do not drop the device, as this can damage the circuitry.
- Always store the device at room temperature.

## How to Warranty Claim JETE Product :

1. All warranty claims can be made at the list of Authorized Outlets listed on the warranty card.
2. Buyers can come to an authorized Outlet or contact Customer Service +62812-1739-3609 if they want to exchange the product online.
3. All expedition shipping costs / product postage are borne by the buyer.
4. When claiming the warranty, the buyer is MANDATORY to show the completeness of the warranty:
  - A purchase receipt that clearly states the name of the outlet and the date of the transaction.
  - The product must still be within the specified warranty period.
  - Warranty card that has been filled out.
  - Box / Packing Product.
5. Please inform the constraints / product damage that occurs to our staff.
6. WARRANTY DOES NOT APPLY if USER DAMAGE is found, namely:
  - BROKEN, CRACKED, BURNED, DROPPED, MODIFIED BY YOURSELF, SUBMERGED IN WATER.
7. If there are problems during warranty claims or other questions, please contact Customer Service +62812-1739-3609

## Terms and Conditions of Warranty :

1. This warranty is valid for 2 years for original JETE products.
2. This warranty is valid for the warranty period stated on the product packaging since the date of sale.
3. During the warranty period, the user is exempt from any replacement costs that may occur.
4. The user must show the warranty card and purchase receipt when applying for a warranty.
5. The warranty applies to functional damage:
  - Disfunction.
  - Audio not detected.
  - Indicator off.
  - Battery damage.
6. This warranty DOES NOT APPLY if:
  - PRODUCT IS BROKEN, CRACKED, BURNED, FALLEN,
  - MODIFIED YOURSELF, SOAKED IN WATER.
  - Supporting accessories such as: cables, adapters, etc.
  - Abnormal use, not stored properly, natural disasters, modified, or anything intentionally.
  - The product has been repaired by a third party.
  - The data is not filled in completely by the seller and buyer.
  - Damage caused by user error.
  - The product warranty period has expired.

**2 YEARS  
WARRANTY**

**NEW REPLACEMENT  
FOR ANY FAULTS \*T&C**



Contact Us

**JETE WARRANTY POINTS**

