

JETE

**WARRANTY CARD and
USER MANUAL**

**SMARTWATCH
ELITE**



e-Usermanual

IMPORTIR

PT. DORAN SUKSES INDONESIA

Jl. Lebak Jaya 2 Tengah No. 2, Surabaya

CUSTOMER SERVICE

 **081217393609**

 jete.id  [jeteindonesia](https://www.instagram.com/jeteindonesia)

 [jeteindonesia](https://www.facebook.com/jeteindonesia)  [jeteindonesia](https://www.twitter.com/jeteindonesia)

JETE

USER MANUAL

SMARTWATCH ELITE



Please read the instructions carefully
before using the product

Introduction :

Thank you for choosing JETE-ELITE. JETE-ELITE is a smart sports watch that will help users to achieve their ideal exercise goals.

Package Content :



JETE-ELITE

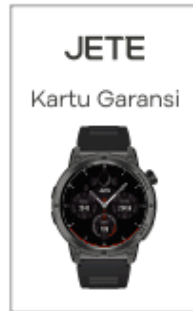

User Manual

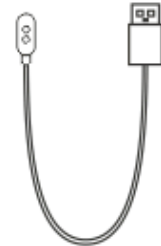

Cable Charging

How to Install and List Applications :

1. Enter the playstore/App store, you can also scan the QR on the packaging
2. Download and install the "JETE CONNECT" application.
3. For the first user, you must register first.
4. Click on the "register" section.
5. Fill in your personal data completely and click register.
6. After successful registration, then log in with the registered account.

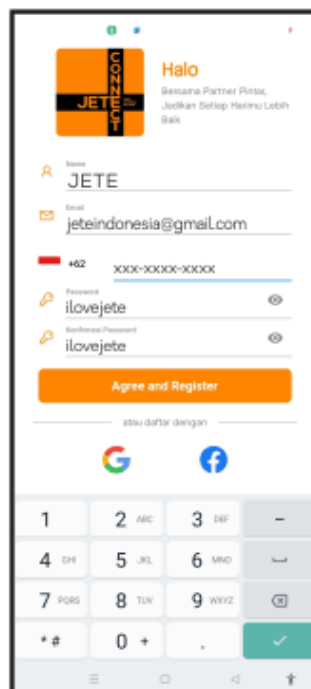



Google Play: JETE CONNECT



App Store: JETE CONNECT



Notes:

This application can analyze the data you provide every day, you can also manage the smartwatch through the JETE CONNECT application such as profile, smartwatch display, notifications, exercise and various other settings.

How to Connect With a Smartphone :

1. turn on the bluetooth function on the smartphone
2. Enter the "JETE CONNECT" application.
3. Select the "DEVICE" menu.
4. Click "Pair DEVICE".
5. Search and select "JETE-ELITE".
6. Make sure the MAC address matches your smartwatch by going to the settings in Smartwatch ---> About.
7. After that there will be a notification on the smartwatch and also the application to immediately confirm the pairing.
8. Then click the check mark on the smartwatch.
9. You can check whether the connection was successful or not through the "JETE CONNECT" app.
10. The blue connection icon on the smartwatch indicates successful app pairing "🔗".
11. Next enter the bluetooth settings on your smartphone.
12. Search and select "JETE-ELITE".
13. Then juxtapose.
14. Blue and orange connection icons on the smartwatch indicate successful pairing of the app and bluetooth "🔗".

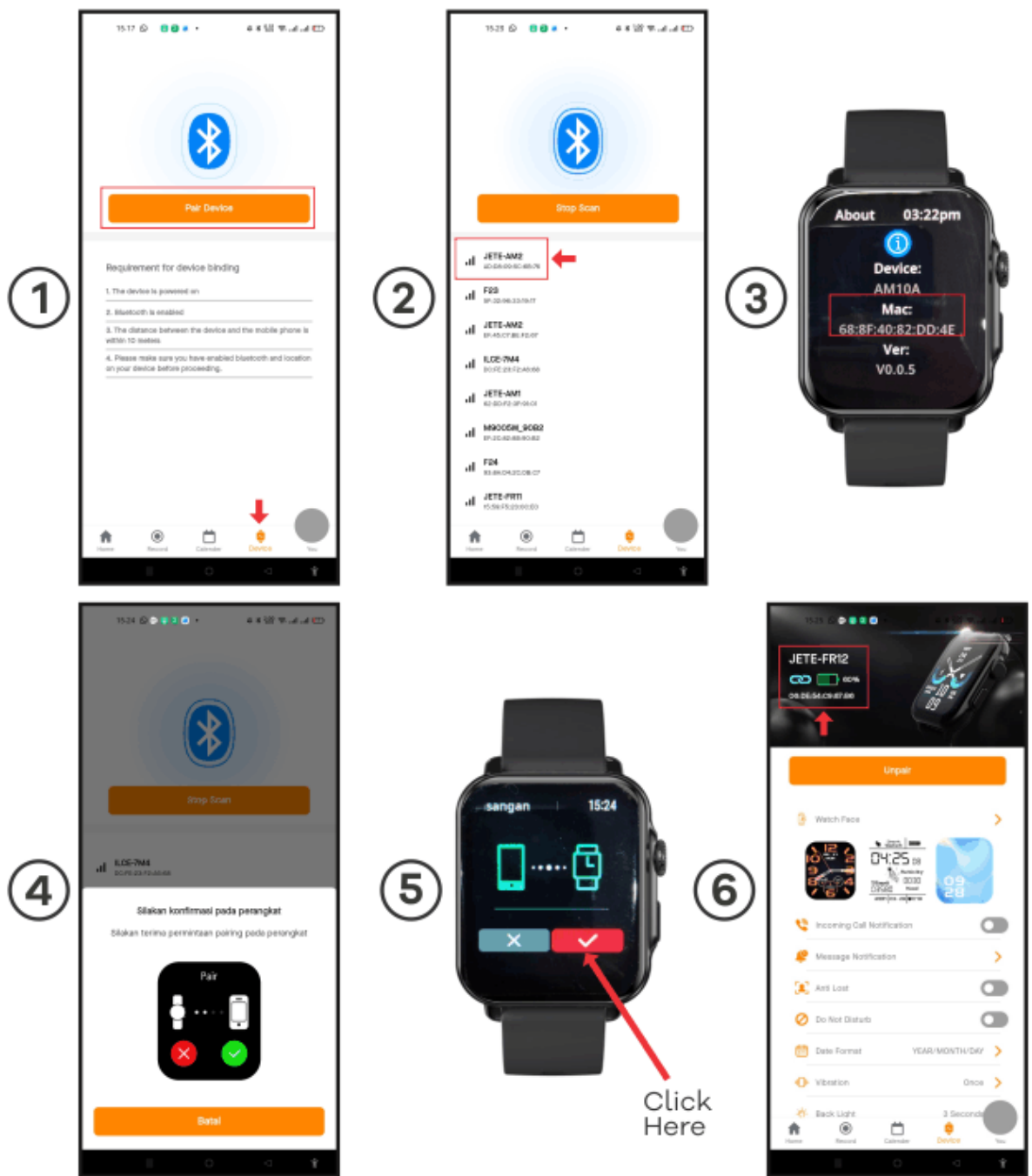

How to Charge :

1. Connect the USB port with the Charger head.
2. Attach the JETE-ELITE with the Charger Cable.
3. Make sure the charging sign appears on the smartwatch screen.
4. Disconnect the charger cable immediately after the battery is fully charged.
5. Do not forget to clean the Charger cable before charging.
6. Charger cables that are dirty or wet will risk an electrical short circuit.

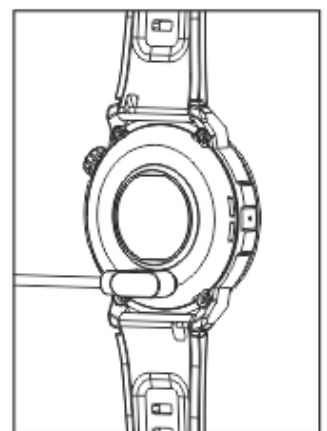

How to Operate a Smartwatch :

How to Change Wallpaper at JETE-ELITE :

How to Change wallpaper at JETE-ELITE:

1. Long press on the JETE-FR22 smartwatch screen
2. Swipe to select the wallpaper.
3. Then Click to confirm
4. You can also rotate the round button on the JETE-ELITE smartwatch to change the Wallpaper.



Notes:

Download more interesting Walpapers via the JETE CONNECT app by:

1. Open the JETE CONNECT app
2. Select the "Device" menu
3. Click "Watch Face"
4. You can choose Online Dial (100+ options available).
5. You can also choose Custom Dial via image from smartphone gallery.

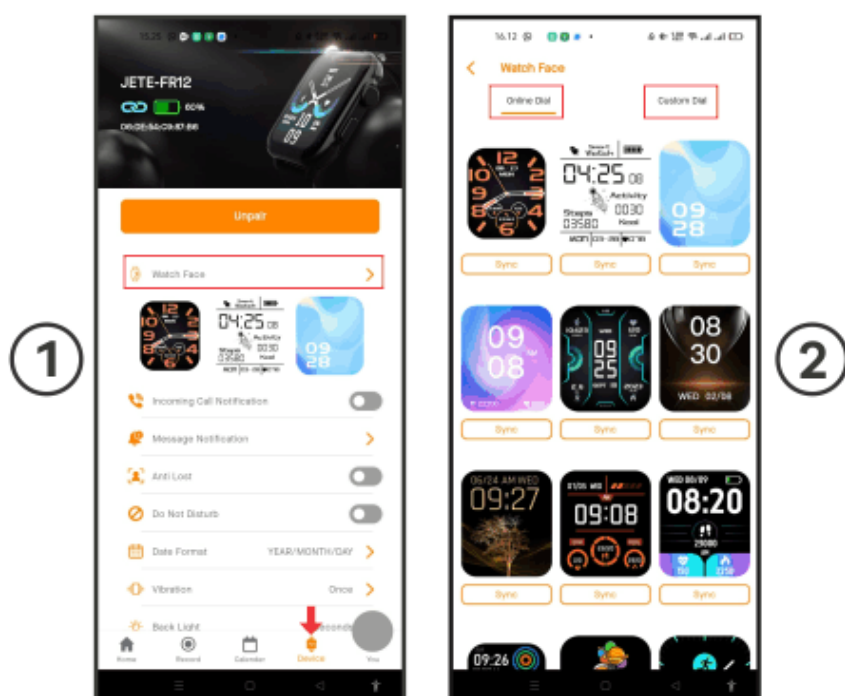

Sport :

JETE-ELITE Supports up to 100+ sports modes such as fitness, relaxation, ball games, dance classes. Including: Walking, running, treadmills, climbing, cycling, bicycle spinning, yoga, basketball, football, badminton, and some other sports. JETE-ELITE supports additional sport modes that can be customized to suit your favorite sports.



Run



Walk



Climbing



Treadmill



Cycling



Yoga



Basketball



Football



Badminton



Free movement

You can choose a sport by :

1. Click the button on the right side of the smartwatch to enter the menu
2. Choose a sport
3. Click to confirm
4. If you want more sports click "Personalize".

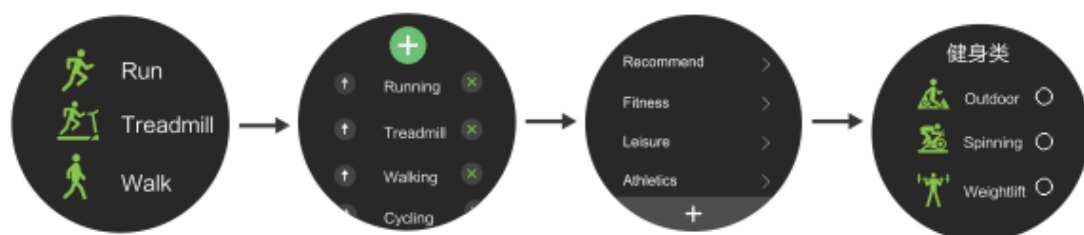

Heart Rate :

Use the smartwatch correctly, not too tight and not too loose, make sure there is a green light on under the smartwatch.

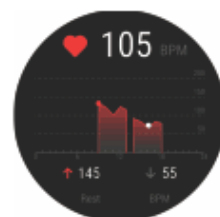

There are 2 ways to use the heart rate feature:

- Turn on the pulse icon on the smartwatch, and measure the heart rate manually
- Automatically adjust, to measure heart rate with intervals at " JETE CONNECT " app.

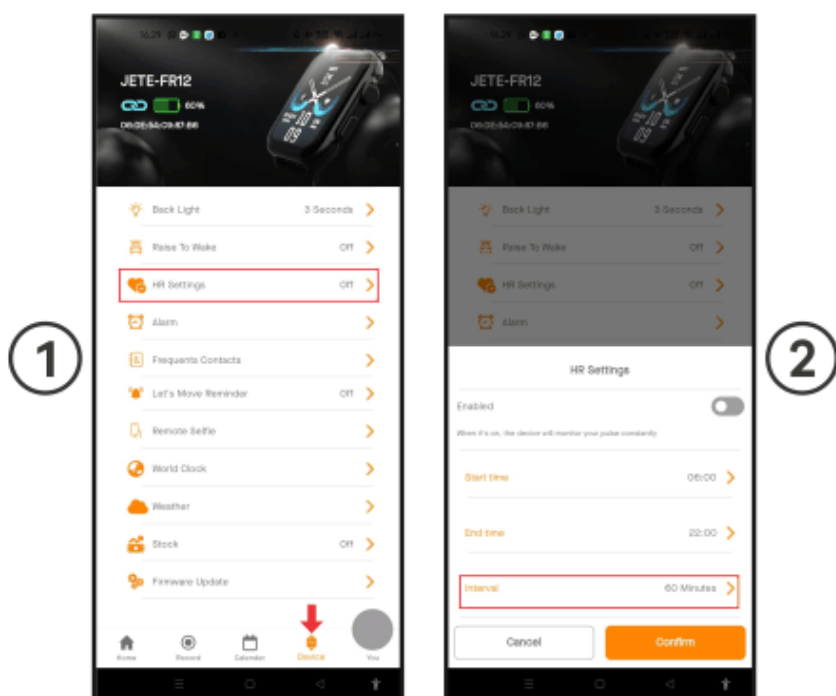

Stress Monitor :

After using the Watch properly, open the "Stress" menu on the watch, check how much psychological stress you're feeling.

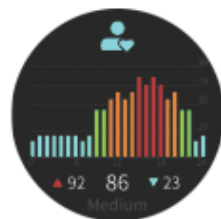

Activity

After using the watch correctly, open the "Track Record" that is on the watch. The watch will show how many steps, calories, distances and some other parameters in a day.

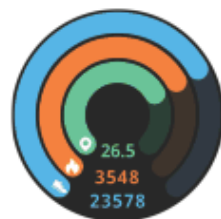

SPO2 :

After using the Clock properly, open the "Blood Oxygen" (SPO2) menu at the clock, the clocks need time to measure the oxygen levels in the blood.

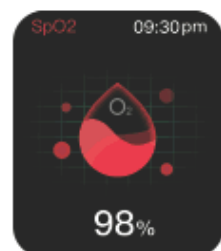

Sleep :

You can control your sleep regularly, by:

1. Wear the JETE-ELITE smartwatch while sleeping.
2. Open the sleep menu.
3. Then go to sleep.
4. The smartwatch will record the sleep status for 1 night.



Call Mode

In the Call menu there are 3 functions:

1. Save contacts. important into JETE-ELITE smartwatch.
2. View call history.
3. Type the call number directly.

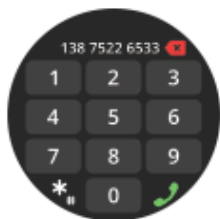

Catatan:

JETE-ELITE supports bluetooth calls. You can answer, end and even reject calls directly from the smartwatch.

Notifications :

You can view messages sent to your smartphone via the JETE-ELITE smartwatch. Set which apps you want to display notifications through the "JETE CONNECT" app.

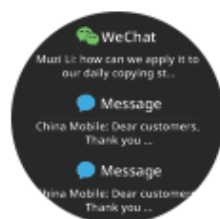

Anti Lost Notification :

When the watch is not connected to the bluetooth of the phone (due to too long distance) the watch will make a sound and vibrate to indicate that the phone/watch is too far away. This function is set via the "JETE CONNECT" app.



Music Player :

On the music menu there are several functions:

1. Play/Pause
2. Next/Prev Music
3. Control Volume
4. you can also play music through your JETE-ELITE smartwatch.



Remote Camera :

You can use JETE-ELITE as a selfie remote by:

1. Open Apps " JETE CONNECT ".
2. Select menu " Device "
3. Click " Remote Selfie "
4. Select Menu " Camera " at the smartwatch
5. Put your smartphone at a decent distance
6. Click " Take Picture " at the smartwatch.

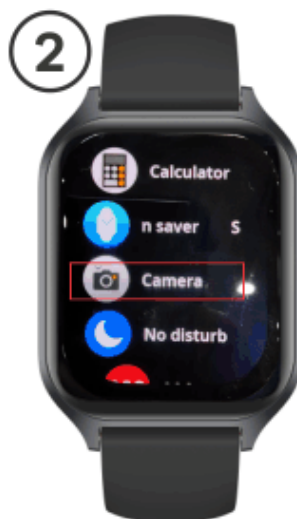
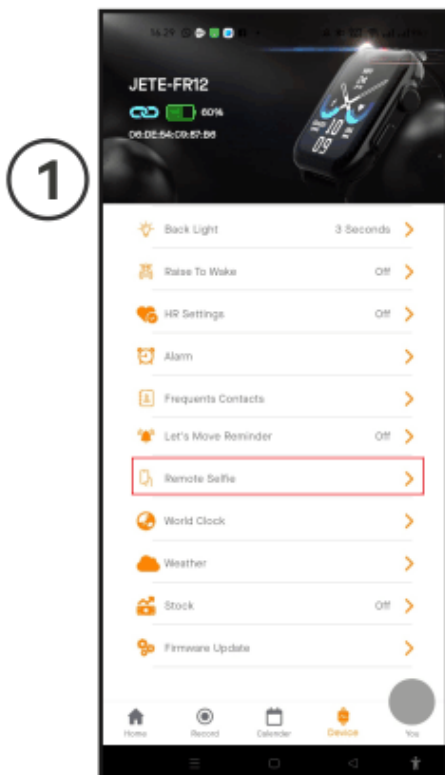

World Clock :

You can see the clocks in different countries, by the way:

1. Open App " JETE CONNECT "
2. Select menu " DEVICE "
3. Click " WORLD CLOCK "
4. Click " ADD "
5. Select the desired country

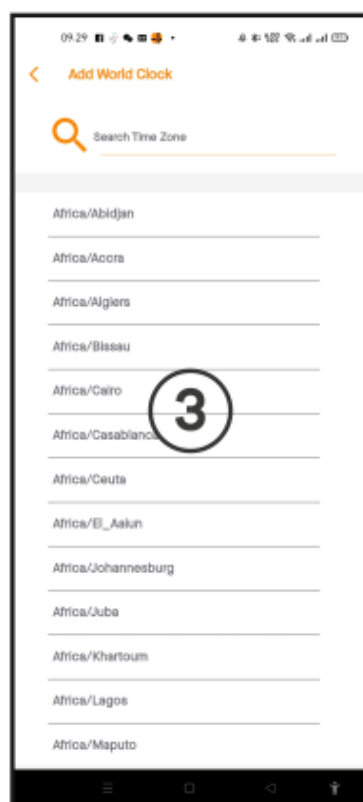
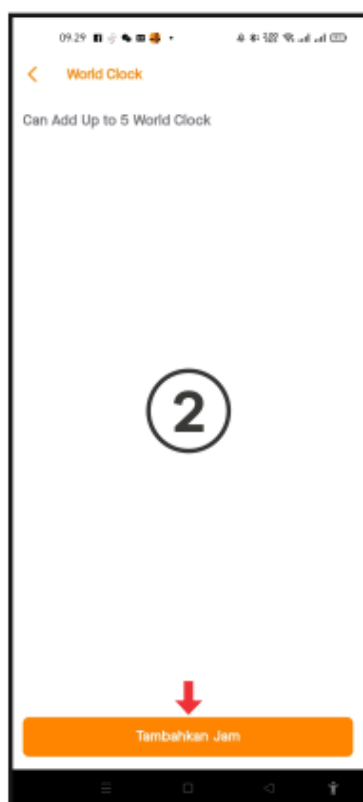
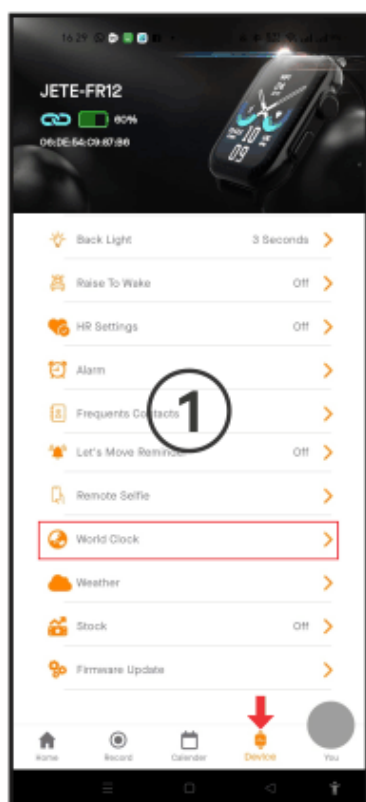
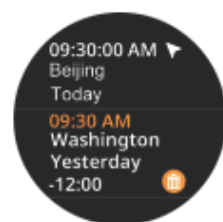

Stock Market :

You can see the Stock Market, by the way:

1. Open App " JETE CONNECT "
2. Select menu " DEVICE "
3. Click " STOCK MARKET "
4. Click " ADD STOCK "
5. Select the desired stock market

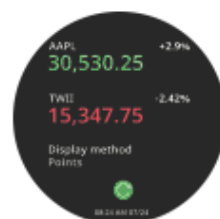

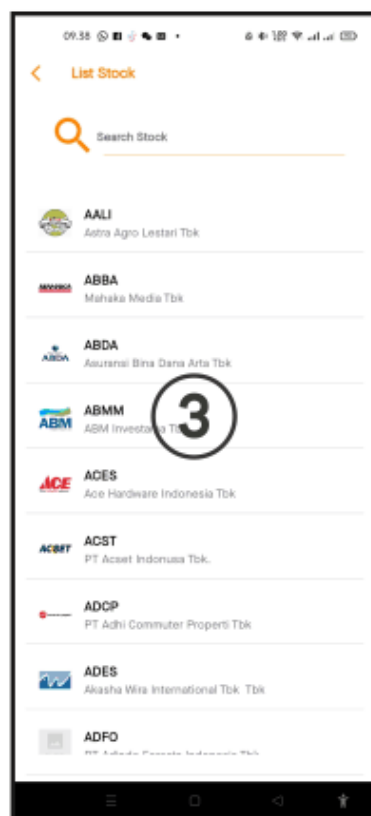
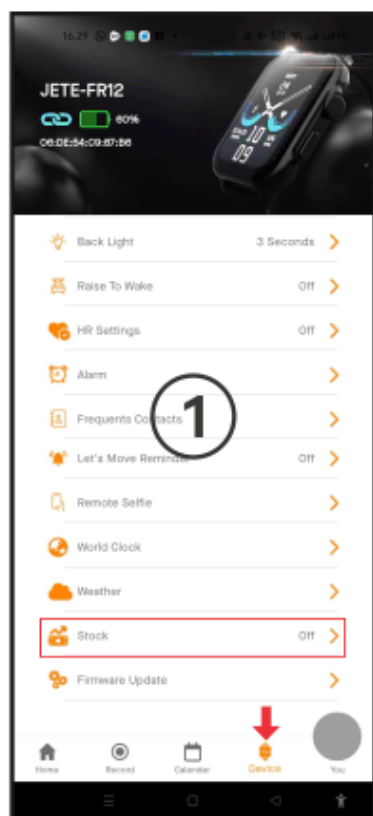

Find Phone :

You can find the smartphone position, by the way:

1. Make sure Smartwatch connect with smartphone
2. Select menu " Find Phone " at smartwatch
3. Your smartphone will automatically beep.
4. This feature will work if you have opened the "JETE CONNECT" application.



Calculator :

For a count.



Calendar :

Check date.



Game :

Playing game



Weather :

See the weather



Alarm :

Set the alarm in the app to be synchronized to the clock, a maximum of 5 alarms, by the way:

1. Open App "JETE CONNECT".
2. Select menu "DEVICE".
3. Click "ALARM".
4. Click "ADD ALARM".
5. Set the alarm.
6. And then click "ADD ALARM".

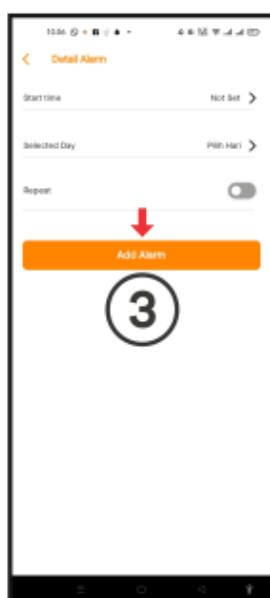
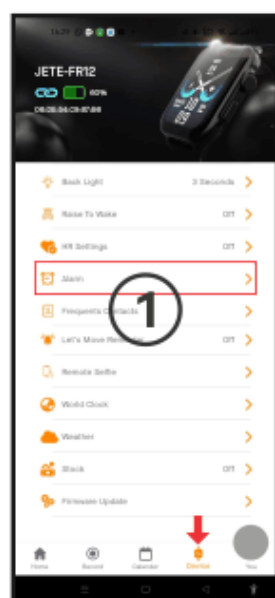

Countdown :

Used to set the countdown time from a specific value. Useful in sports, cooking, presentations, or tasks that require limited time monitoring.

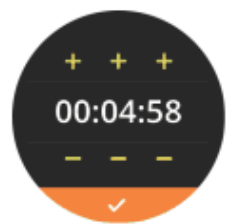

Stopwatch :

Used for accurate timing, whether in sports, research, training or other purposes.

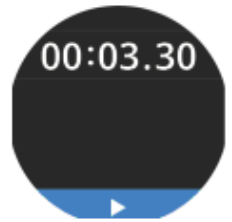

Menu Shortcuts :

1. Bluetooth 3.0
2. screen on for 5 minutes
3. Alarm
4. Brightness
5. Barcode
6. Setting
7. Don't Disturb Mode



How to Use NFC :

1. Open the access control on the locking product software, then add the device.
2. Bring the smartwatch close to the sensor area on the locking product, the NFC feature will automatically activate.
3. Once successful, when the smartwatch is brought near the sensor area, the lock will unlock.

Spesification :

Screen Size	: 1.39" AMOLED
Screen Resolution	: 360*360 Pixels
Battery Capacity	: 300 mAh
BT Range	: 8 – 10m
Working Time	: 4 – 5 Days
Standby Time	: 10-20 Days
Water Resistance	: IP67
Body Material	: Zinc Alloy main body + Plastic Case
Band Material	: Silicone Strap
Machine Weight	: 51g

Problems :

Heartbeat Signal Lost

JETE Smart Watch keeps an eye on your heart rate during exercise and your daily life. Sometimes the watch signal may not match. If this happens, the missing heart rate will appear on the dot line.

If you cannot use the heart rate signal, first of all, make sure you are wearing the watch correctly, avoid fitting it too high or too low, and also not too tight or not too loose on your arm. Once adjusted, click the heart rate icon to retrieve the data. If there is still no heart rate data, check the heart rate function in the app to make sure it is active.

Other Problems :

If your phone cannot connect to the watch, click the Bluetooth settings on your phone and check if there is a JETE battery. If there is, it means there is no problem in the Bluetooth signal, Please check maybe the clock is connected to another cellphone, please disconnect immediately. IOS users should click Settings - Bluetooth - Forget device and connect.

Caution :

1. JETE Smartwatch data of heart rate, blood oxygen, and blood pressure, cannot be used as a benchmark for diagnosis.
2. Self-diagnosis and self-treatment are dangerous. Only a qualified person can diagnose and treat high blood pressure, or other heart diseases. Please contact a doctor for further diagnosis.
3. The data of heart rate, blood pressure, etc. of the JETE smartwatch may not be completely accurate due to factors such as external and environmental interference, improper use, and the user's physical condition.
4. Do not give medicines and treatments on the basis of those provided by the JETE smartwatch, and should follow the doctor's advice. and we are not responsible for any inaccuracies about the data and consequences provided.

Maintenance :

Please read the following recommendations before using JETE

- Avoid exposing the device to water vapor or humid places. This can affect the internal circuit.
- Do not use cleaning solutions to clean the device.
- Do not expose the device to extreme heat or cold, as this can damage the device or change certain plastic parts.
- Avoid exposing the device to sharp objects, as this can cause scratches and damage.
- Do not disassemble or modify the device.
- Do not drop the device, as this can damage the circuitry.
- Always store the device at room temperature.

How to Warranty Claim JETE Product :

1. All warranty claims can be made at the list of Authorized Outlets listed on the warranty card.
2. Buyers can come to an authorized Outlet or contact Customer Service +62812-1739-3609 if they want to exchange the product online.
3. All expedition shipping costs / product postage are borne by the buyer.
4. When claiming the warranty, the buyer is **MANDATORY** to show the completeness of the warranty:
 - A purchase receipt that clearly states the name of the outlet and the date of the transaction.
 - The product must still be within the specified warranty period.
 - Warranty card that has been filled out.
 - Box / Packing Product.
5. Please inform the constraints / product damage that occurs to our staff.
6. **WARRANTY DOES NOT APPLY** if **USER DAMAGE** is found, namely:
 - **BROKEN, CRACKED, BURNED, DROPPED, MODIFIED BY YOURSELF, SUBMERGED IN WATER.**
7. If there are problems during warranty claims or other questions, please contact Customer Service +62812-1739-3609.

Terms and Conditions of Warranty :

1. This warranty is valid for 2 years for original JETE products.
2. This warranty is valid for the warranty period stated on the product packaging since the date of sale.
3. During the warranty period, the user is exempt from any replacement costs that may occur.
4. The user must show the warranty card and purchase receipt when applying for a warranty.
5. The warranty applies to functional damage:
 - Disfunction.
 - Audio not detected.
 - Indicator off.
 - Battery damage.
6. This warranty DOES NOT APPLY if:
 - PRODUCT IS BROKEN, CRACKED, BURNED, FALLEN,
 - MODIFIED YOURSELF, SOAKED IN WATER.
 - Supporting accessories such as: cables, adapters, etc.
 - Abnormal use, not stored properly, natural disasters, modified, or anything intentionally.
 - The product has been repaired by a third party.
 - The data is not filled in completely by the seller and buyer.
 - Damage caused by user error.
 - The product warranty period has expired.

**2 YEARS
WARRANTY**



Contact Us

JETE WARRANTY POINTS

